

# Omegalarm

## 4012/8012

### Security System

### User's Guide

**OMEGALARM**  
By Radonics Inc.

FOR USE ON CALIFORNIA FIRE MARSHAL INSTALLED SYSTEMS ONLY  
FOR ALLOWABLE SUPPLY VOLTAGE ONLY

• Common Terminals - Not Grounded  
Fuse use only SEE 14 AMP.

**PROTECTIVE ZONES**  
For full suspension a 1000 OHM Resistor  
must be at far end of Line

LOOP 1    LOOP 2    LOOP 3    LOOP 4

**Terminal Block:**

1	TRANSFORMER	Class II	16.5 VAC 20 VA	Radonics #1820
2	AUX POWER R	12 VDC	500 mA Max	
3	COMMON	Aux Power and Bell		
4	BELL	12 VDC	1.5 Amp Max	
6	BRN	TR	Bond	
7	GRY	AI	PHONE Connections	
8	GRN	Y	Wrong	
9	RED	R	Loop Code	
J7	EARTH GROUND	Groundstart	LED on	
		Radonics #18	Radonics #18	

**Terminal Block:**

J9	Disable/Restart	
VIC	31	Green LED Loop Status
GRN	30	DIGITAL KEYPAD
BRN	29	Radonics #1801/1114
BLU	28	Wire Color Code
WHT	27	Yellow Wire Panel Loop
BLK	26	
RED	25	Red LED and Postmaster Arm
ORN	24	Firearm Buzzer 3 Maximum
23		MASTER ARM
22		FORCE ARM
J10		6 zone only
J11		Status Report
J12		Response 1200 Board
J13		Battery Report Trip

# **Omegalarm 4012/8012 Security System User's Guide**

Take a few minutes to read through this guide and familiarize yourself with the basic operation and controls of your new Omegalarm Security System. Each system is unique and uses different types of protective devices that may require special operating instructions. Ask your security consultant if you have any questions not covered in this guide.

## **Table of Contents**

**Your Alarm Company is:**

Call before test \_\_\_\_\_  
\_\_\_\_\_  
\_\_\_\_\_

	Page
Exit/Entry Delay .....	3
Arming the System.....	3
Disarming the System.....	3
When Your Alarm Sounds .....	3
Zone Description.....	4
Arming Stations .....	5
Digital Keypad Arming Stations .....	5
Perimeter Arming Only (optional) .....	5
Key Switch Arming Station .....	6
Green Ready Light .....	6
Red Armed Light .....	7
Central Station Monitored Systems .....	8
Testing Your Security System .....	9
Optional Omegalarm Accessories .....	9
Glossary .....	10

The Omegalarm Security Control is the center of your security system. Using advanced microcomputer technology, the security control automatically decodes and responds to the information it receives from the protection devices making up your system (smoke detectors, motion detectors, door contacts, etc.). Instructions for the security control are programmed into the microcomputer by your security technician allowing for flexibility and customization of each Omegalarm System. The diagram below shows how all the devices in the system are centered around your Omegalarm Security Control.

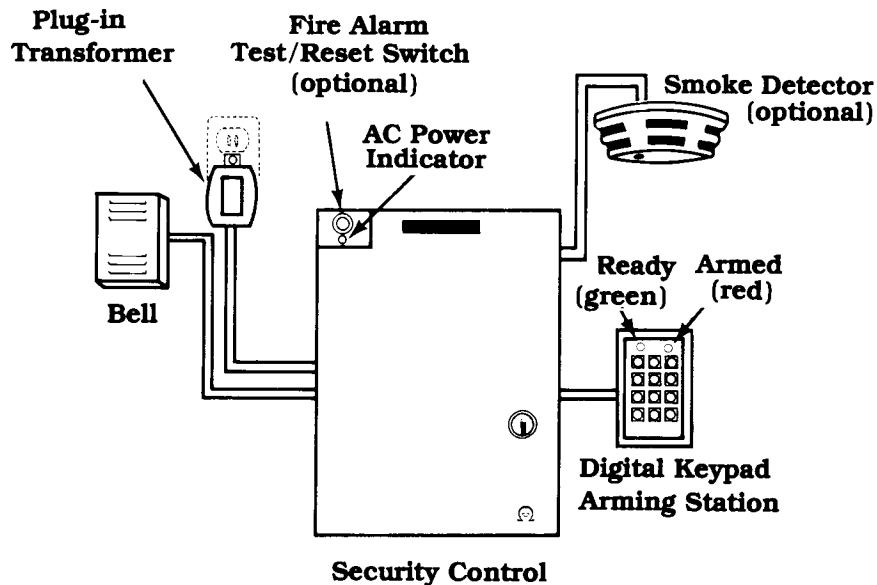

## Exit/Entry

The Omegalarm has a delay period (programmable from 10 to 90 seconds) that allows you to exit and enter the building when **arming** and **disarming** without setting off the alarm. At least one zone is designated as the **delay zone**.

## Arming the System

- Insure that green **Ready** light is on.
- Enter combination or activate with key.
- The red **Armed** light will begin flashing indicating that the exit delay has started.
- Exit the building immediately.
- The **Armed** light will glow steady when the system **arms**.
- Closing reports are sent (optional).
- Bell test occurs after system **arms.** (optional)

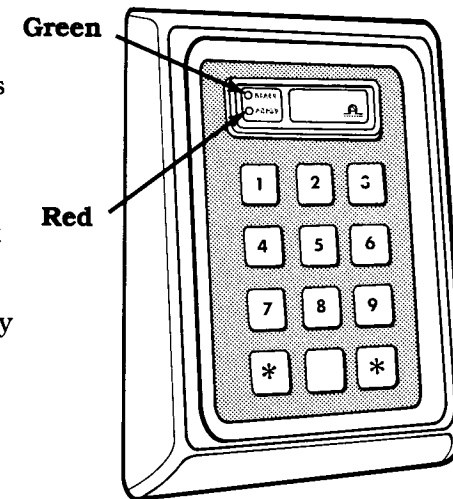

## Disarming the System

When **disarming** the system, enter **only** through the designated delay zone. Entering through any other zone will cause an immediate alarm.

- Enter building.
- Warning buzzer sounds to remind you to disarm the system.
- Enter combination or activate with key.
- **Armed** light goes out and buzzer stops when system **disarms**.
- Opening report is sent after **disarming.** (optional)

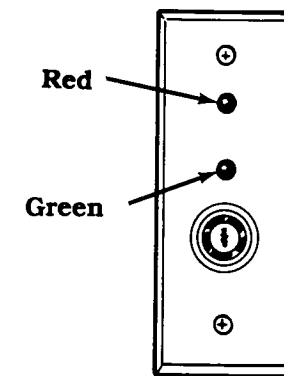

## When Your Alarm Sounds

The Omegalarm is equipped to sound both an outside audible and an interior warning device such as a bell or siren. The audible alarm will sound immediately if any of the burglary zones (except the delay zones) are tripped while the system is **armed**. The audible alarm will also sound if the entry delay period is allowed to expire before the system is **disarmed**. To turn the audible alarm off, simply enter your combination code or use your key to reset the system. Zones can be silent or audible as an installation option.

## Zone Description

Your Omegalarm Security System is divided into either four or eight areas of protection called zones. There are three types of zones:

**24 hour: Armed** constantly, these zones are used to instantly report a panic, hold-up, fire, medical or other emergency.

**Interior:** Used for all interior forms of protection (carpet mats, motion sensors, inside doors, etc.). Interior zones are **armed** and **disarmed** at the arming station.

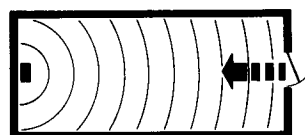

Ultrasonic



Photoelectric Beams

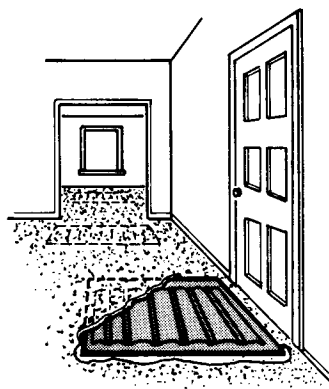

Pressure Mats

**Perimeter:** All exterior doors and windows of the building forming the outside "wall of protection". Can be **armed** and **disarmed** separately from the interior zones.

If any of the zones are faulted while **armed**, an audible warning will sound (optional by zone) and a signal is transmitted to a central receiving station. The signal contains your account number and a special code that identifies the reason for the signal. Trained personnel at the central station dispatch the proper authorities in response to this signal.

## Arming Stations

**Arming** and **disarming** the intrusion/burglary portion of your Omegalarm Security System is done with either Key Switch or Digital Keypad arming stations. Each arming station is equipped with indicator lights to show you the status of the security system at a glance.

## Digital Keypad Arming Stations

You operate your Omegalarm Security System from a digital keypad using your own secret combination code. There are several models of Omegalarm Digital Keypads. Each has the red and green status lights and a built-in warning buzzer that alerts you of an open door or window when you are entering your combination for **arming**. It will also sound to remind you to **disarm** the system when entering the building. Contact your alarm service company if you wish to change your combination.

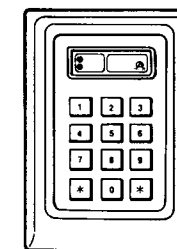
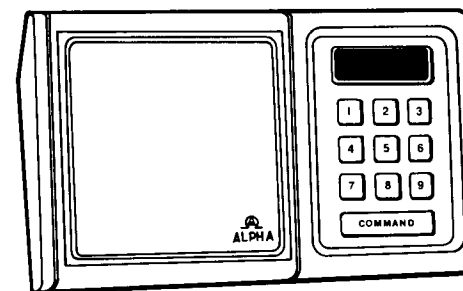
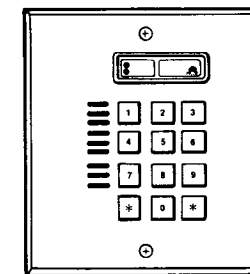
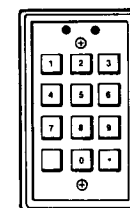
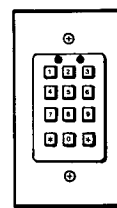

## Omegalarm Digital Keypad Arming Stations

### Perimeter Arming Only (optional)

You can **arm** just the **perimeter** zones of your Omegalarm Security System by pressing the right asterisk button. This feature allows you to remain inside of the protected premises while having the outside "wall of protection" secured.

**NOTE:** While the system is in the **perimeter armed only** mode there is no exit delay. In order to leave the building you must first **disarm** the perimeter then **arm** the entire system using your combination code.

## Key Switch Arming Station

Key Switch Arming Stations can be used in place of or in addition to the Digital Keypad Arming Stations. The functions of the **status lights** are the same for both types of arming stations. The Key Switch arming stations are used for **arming** all of the zones. However, additional switches can be added to provide the **perimeter arming only** features.

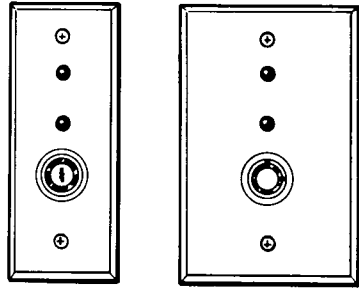

**Omegalarm  
Keyswitch  
Arming  
Stations**

## Green Ready Light

The green **Ready** light on the arming stations indicate the present status of your security system sensors.

**On** - When the green light is **on**, your system is **“ready”** to be **armed** and the A.C. and battery power are normal.

**Off** - When the green light is **off** (and pressing one of the digital keys causes the buzzer to sound), the system cannot be **armed**. Check that all protected doors and windows are closed and that all space protection devices (electric eyes, infra-red beams, etc.) are not blocked.

If the green light does not come on after you have determined that all of the protective zones are normal, press one of the digital keys again. If the buzzer does not sound while the key is pressed, this indicates a possible power supply problem exists. Your security system, however, can still be **armed** in this condition. Insure that the A.C. transformer of the Omegalarm is properly plugged into a wall outlet and that the circuit breaker has not been tripped. Call your alarm service company to report the condition.

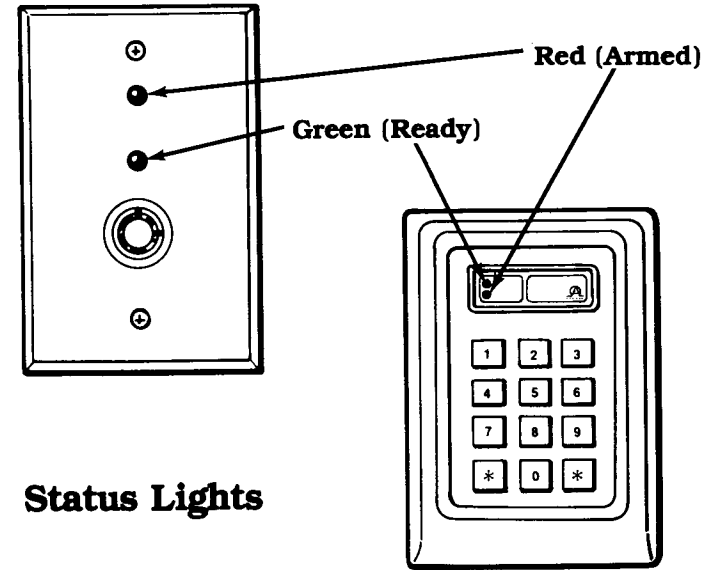
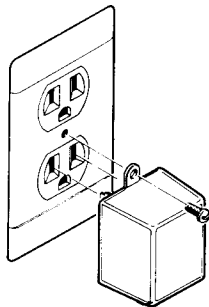

**Status Lights**

## Red Armed Light

The red Armed Status light indicates if your security system is in the **armed** or **disarmed** mode.

**Off** - When the red light is **off** your system is **NOT armed**.

**On - Flashing** - The red light will begin flashing when you enter the combination code to **arm** your system. This indicates that exist time has begun. The red light will continue to flash during the exit delay period or until a closing report has been sent (optional).

**On - Steady** - Under normal conditions, after the exit delay has expired, the red light will remain on continuously as long as the system remains **armed**.

**Flashing - Slowly** - If, while the system is **armed**, the red light begins to flash slowly (it is off longer than it is on) the stand-by battery power is low. This condition may occur if the A.C. power is off or the audible alarm sounds for an extended period of time. The battery will recharge and the light will stop flashing once the power is restored or the audible silences.

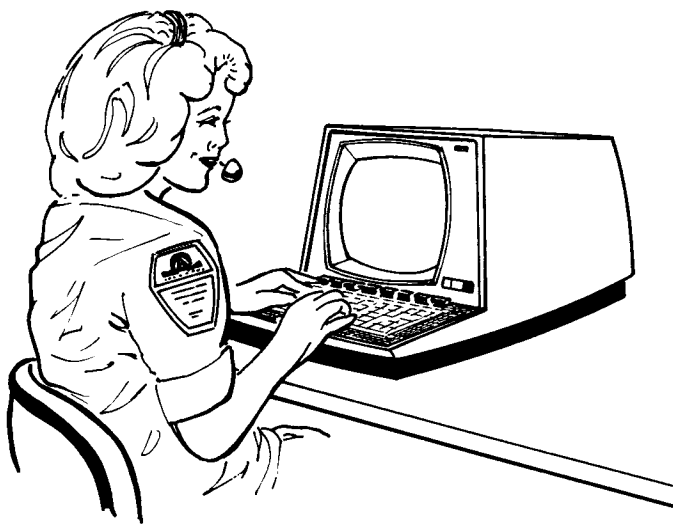

## Central Station Monitored Systems

The Omegalarm Security System can be used in two ways: as a local alarm system where it only sounds an audible alarm at the protected premises; or as a monitored system where it sounds an audible alarm **and** sends signals to a central monitoring station.

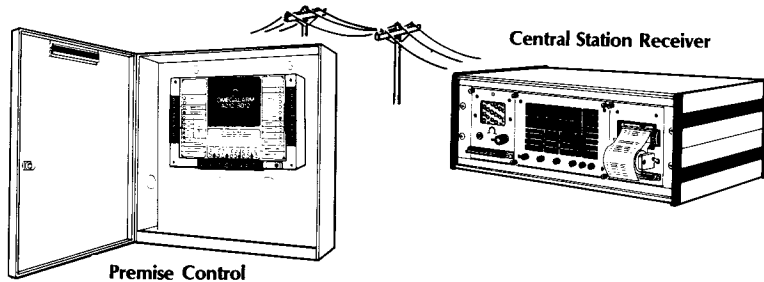

Monitored systems utilize the existing telephone system to report to the central station. To prevent any interference during transmission, your telephone is temporarily disconnected for a few seconds until the transmission is over. Specially trained personnel at the central station will dispatch the proper authorities upon receiving a signal from your system. Through your subscriber account number and alarm information received, they know where the alarm occurred, what responding agency to send and who to notify during an emergency. You must supply a list to your alarm company of responsible persons to be notified in the event of an emergency.



## Testing Your Security System

To insure that the communication link between your security system and the central station is operating properly, it is recommended that you test the system periodically. To prevent a false alarm from being reported **CALL YOUR ALARM COMPANY BEFORE YOU TEST**. Ask your security consultant for details on the procedure and phone numbers to use when testing your security system.



## Optional Omegalarm Accessories

### Independent Zone Control

When 24-hour security is required on a specific room or area, the Omegalarm Independent Zone Control module allows you to control that zone separately from the rest of the security system. **Disarming** the area is done with either a **Key Switch** or a **Digital Keypad Arming Station**. Entry and exit delays are provided with a warning buzzer to remind you to **disarm** the zone upon entry. When the green **Ready** light is on, the zone is secure and ready to be **armed**. The red **Armed** light comes on when the zone control module is **armed**. After the exit delay expires, the green light will go out.

### Zone Annunciation

Individual zone status annunciation can be shown at either your Omegalarm Communicator or at a convenient remote location. When all the status lights are off, all burglary zones are secure and the system can be **armed**. If any of the lights are on, check for an open door or window on that zone.

### Test Report Timer

Testing the communications of your security system can be done automatically with a Test Report Timer. At a predetermined time your Omegalarm Communicator will send a designated test signal insuring that the communications between your location and the Central Station is operational.

### Bell Test

Equipped with an optional Bell Test module, your Omegalarm Communicator will briefly sound the audible alarm automatically each time the system **arms**. This checks the audible alarm operation and verifies that the Central Station has received your closing report (optional).

## Omegalarm Security Systems Glossary

As security system technology has evolved, a special jargon has developed. Some terms widely used within the industry are these:

**Arming Station** - Though simply called an **arming station**, these devices are used for **disarming** as well as **arming** security systems. Arming stations may utilize **key switches** or **digital keypads** for actually **switching** the security system ON or OFF. Omegalarm arming stations also incorporate **status** lights to provide visible indication if the circuits are intact (all points of protection are normal) and if the system is armed or disarmed. A prewarn alert is also incorporated to remind the user to **disarm** the system after a secured entry door has been opened.

**Central Station** - A facility that is manned by trained personnel around the clock to communicate emergency information to the proper authorities.

**Closing Report** - A signal to the central station indicating that the system is **armed** (a report normally used by business to indicate that the business is now **closed**).

**Digital Communicator** - An electronic device that utilizes the existing telephone system at a protected facility to transmit information to the central station. Information transmitted includes system account number, type of alarm, battery condition, test reports and more.

**Digital Keypads** - An arming station that accepts a programmable series of numbers to **arm** and **disarm** security systems. Omegalarm **digital keypads** are decoded at the security control providing a high degree of security. Digital keypads have an advantage over **key switches** in that they are not subject to loss or duplication like keys.

**Entry/Exit Delays** - A programmable **delay** of arming provided by the security control to facilitate leaving a premises after the system has been **armed**. A delay upon entry through selected doors is also provided to give the user an opportunity to **disarm** the system before an alarm is initiated. Entry/Exit delays allow installation of arming stations **within** the protected premises to provide greater protection against tampering and compromise attempts.

**Master Arm** - An **armed** mode that includes **all** of the protective devices.

**Opening Report** - A signal sent to the central station indicating that the system is **disarmed** (a report normally used by business to indicate that the business is now **open**).

**Perimeter Arm** - An **armed** mode that includes **only** those protective devices that are part of the perimeter of the premises. Protective devices in the interior of the premises are not **armed** in this mode.

**Restoral Report** - A signal sent to the central station indicating that a fault in a zone has been **restored** to normal.

**Security Control** - The **logic** portion of a security system. It provides power to protective devices and audible devices; it controls the **arming** and **disarming** of all portions of the system; it communicates emergency signals to remote locations; and it provides for a host of other functions such as self diagnostics, keypad decoding and **seizure** of the telephone line during an emergency.

**Shunting** - The process of deliberately deleting specific zones of protection when arming the system. To **shunt** the zone with a motion detector, for example, would be to delete that zone from the protection.

**Trouble Report** - A signal sent to the central station to indicate an abnormal condition in a zone, battery, etc.

**Zone** - Segregated groups of protective devices or protected areas such as **delay** doors, **instant** doors, windows, heat detectors, motion detectors, etc.

## Optional Megalarm Accessory

### Panic Alarm

By pressing both right and left asterisks simultaneously you can send an emergency panic alarm to the central station. This feature can be programmed to either be silent or to sound an audible alarm.

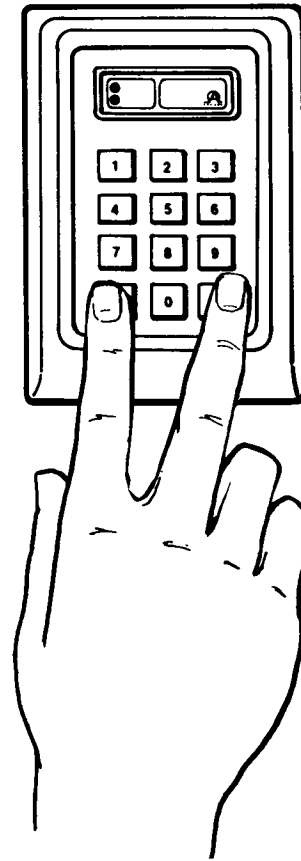



The Omegalarm security control is equipped with the optional Fire Test and Reset module. This module serves three functions;

1) To monitor A.C. power to the security control. Periodically check to insure that the red light is on. If the red light is out, investigate the cause immediately. Check that the A.C. transformer is properly plugged in and that the circuit breaker has not been tripped. The circuit breaker for the alarm system should be clearly marked and **never** turned off. If you cannot correct the problem, contact your alarm company immediately.

2) To reset tripped smoke detectors. Whether the fire alarm is tripped by cooking, heavy tobacco smoke or an actual fire, the smoke detectors must be reset before they can detect another fire. The system's warning buzzer will sound continuously if the smoke detectors need to be reset, to indicate trouble with the fire alarm system and during a fire system test. To reset the smoke detectors, first make sure the room is clear of smoke, then press and release the reset switch **once**. **NOTE: Entering your combination at the keypad will not silence the warning buzzer.** Call for service if the warning buzzer cannot be silenced with the reset switch.

3) To test the communications between your security system and the central station. **Notify your alarm company BEFORE testing to prevent fire/police department response.** Be ready to silence the audible alarm after the test. Hold the switch depressed for 10 seconds to trip the alarm and to test the stand-by power support (battery) of the system. Release the switch and silence the audible alarm by entering your combination code at the digital keypad or by using your keyswitch to reset the system.

**NOTICE:** If it is determined that the alarm was accidentally tripped, the audible alarm should be silenced, the smoke detectors reset and your alarm company notified immediately.